

bühler

farm king

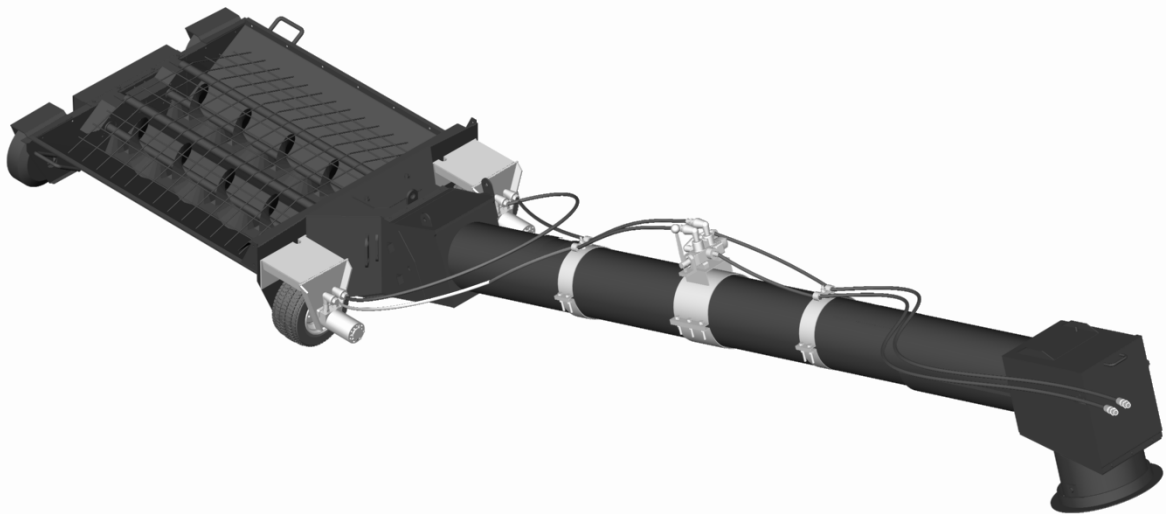

10" & 13" Power Mover

Operator's and Parts Manual
FK368

2009

WARRANTY POLICY

Buhler Manufacturing products are warranted for a period of twelve (12) months (90 days for commercial application) from original date of purchase, by original purchaser, to be free from defects in material and workmanship under correct, normal agricultural use and proper applications.

Buhler Manufacturing's obligations under this warranty shall be limited to the repair or exchange, at Buhler Manufacturing's option, of any Buhler Manufacturing product or part which proves to be defective as provided. Buhler Manufacturing reserves the right to either inspect the product at the buyer's location or have it returned to the factory for inspection.

The above warranty does not extend to goods damaged or subject to accident, abuse or misuse after shipment from Buhler Manufacturing's factory, nor to goods altered or repaired by anyone other than an authorized Buhler Manufacturing representative.

Buhler Manufacturing makes no Express Warranties other than those, which are specifically described. Any description of goods, including any references and specifications in catalogues, circulars and other written material published, is for the sole purpose of identifying goods and shall conform to such descriptions. Any sample or model is for illustrative purposes only and does not create an Express Warranty that the goods conform to sample or model shown.

The purchaser is solely responsible for determining suitability of goods sold. This warranty is expressly in lieu of all other warranties expressed or implied. Buhler Manufacturing will in no event be liable for any incidental or consequential damages whatsoever. Nor for any sum in excess of the price received for the goods for which liability is claimed.

WARRANTY CLAIMS:

Warranty requests must be prepared on Buhler Manufacturing Warranty Claim Forms with all requested information properly completed. Warranty Claims must be submitted within a thirty (30) day period from date of failure repair.

WARRANTY LABOR:

Any labor subject to warranty **must** be authorized by Buhler Manufacturing. The labor rate for replacing defective parts, where applicable, will be credited at 100% of the dealer's posted shop rate. Defective parts will receive an extra 10% discount to assist with freight or other incidental costs.

GOVERNMENT LEGISLATION:

Warranty terms and conditions are subject to Provincial or State legislation.

IMPORTANT FACTS:

Buckets and Bucket Tines Carry No Warranty
Bent Spears Carry No Warranty
Snowblower Fan Shafts Carry No Warranty
Mower Blades Carry No Warranty
Portable Auger Parts Have Two (2) Year Warranty
Loader Parts Have Two (2) Year Warranty

IMPORTANT NOTE: This warranty does not apply to rentals

INTRODUCTION

The Buhler Farm King 2 wheel power mover allows you to move your Backsaver hopper back and forth with fingertip control. It includes many features such as easy access ports for servicing.

Keep this manual handy for frequent reference. All new operators or owners must review the manual before using the equipment and at least annually thereafter. Contact your Buhler Dealer if you need assistance, information, or additional copies of the manual. Visit our website at www.buhler.com for a complete list of dealers in your area.

The directions left, right, front and rear, as mentioned throughout this manual, are as seen facing in the direction of travel of the implement.

SAFETY

Remember, YOU are the key to safety. Good safety practices not only protect you, but also the people around you. Make these practices a working part of your safety program. Be certain that everyone operating this equipment is familiar with the recommended operating and maintenance procedures and follows all the safety precautions. Most accidents can be prevented. Do not risk injury or death by ignoring good safety practices.

The alert symbol is used throughout this manual. It indicates attention is required and identifies hazards. Follow the recommended precautions.



The safety alert symbol means...

ATTENTION! BECOME ALERT! YOUR SAFETY IS INVOLVED!



CAUTION

The caution symbol indicates a potentially hazardous situation that, if not avoided, may result in minor or moderate injury. It may also be used to alert against unsafe practices.



WARNING

The Warning Symbol indicates a potentially hazardous situation that, if not avoided, could result in death or serious injury, and includes hazards that are exposed when guards are removed. It may also be used to alert against unsafe practices.



DANGER

The Danger Symbol indicates an imminently hazardous situation that, if not avoided will result in death or serious injury. This signal word is to be limited to the most extreme situations, typically for machine components that, for functional purposes, cannot be guarded.

GENERAL SAFETY INSTRUCTIONS

Have a first-aid kit available for use and know how to use it.

Have a fire extinguisher available, stored in a highly visible location, and know how to use it.

Wear appropriate protective gear. This list may include but is not limited to:

- Hard hat
- Protective shoes with slip resistant soles
- Protective glasses or goggles
- Heavy gloves
- Wet weather gear
- Hearing protection
- Respirator or filter mask

Read and understand the Operator's Manual and all safety signs before operating, servicing, adjusting, repairing, or unplugging the equipment.

Review Auger Operator's Manual before operating.

Do not attempt any unauthorized modifications to your Buhler product as this could affect function or safety, and could affect the life of the equipment.

Inspect and clean the working area before operating.

Keep hands, feet, clothing, and hair away from moving parts.

Ensure bystanders are clear of the area before operating.

START-UP SAFETY

Do not let inexperienced operators or children run this equipment.

Place all tractor and machine controls in neutral before starting.

Ensure all shields are in place and in good condition before operating.

OPERATION SAFETY

Do not permit riders.

Do not wear loose fitting clothing during operation.

The Backsaver Auger should be attached to the drawbar of the tractor at all times during operations.

Do not allow anyone other than the operator close to the Auger when in operation.

Never operate the equipment in the raised position.

TRANSPORT SAFETY

Review Transport Safety instructions in tractor manual before moving.

Check with local authorities regarding transport on public roads. Obey all applicable laws and regulations.

Make sure the SMV (Slow Moving Vehicle) emblem and all the lights and reflectors that are required by the local highway and transport authorities are in place, are clean, and can be seen clearly by all overtaking and oncoming traffic.

Never have the equipment in operation during transport.

Take extreme caution in maneuvering on or around tight corners so as not to catch the end of the auger on trees, buildings, power lines, etc.

Always travel at a safe speed.

SERVICE AND MAINTENANCE SAFETY

Stop engine, set brake, remove ignition key, and wait for all moving parts to stop before servicing, adjusting, repairing, or unplugging.

Support the equipment with blocks or safety stands before working beneath it.

Follow good shop practices including

- Keep service area clean and dry
- Be sure electrical outlets and tools are properly grounded
- Use adequate light for the job

Use only tools, jacks, and hoists of sufficient capacity for the job.

Replace and secure all shields removed during servicing before operating.

Use heavy leather gloves to handle sharp objects.

Check hydraulics regularly for leaks. Use cardboard to look for leaks, and use hand and eye protection.

Relieve pressure on hydraulic system before repairing or adjusting.

Inflate tires to recommended pressure.

Failure to follow proper procedures when mounting a tire on a wheel or rim can produce an explosion, which may result in serious injury or death.

STORAGE SAFETY

Store the unit in an area away from human activity.

Do not permit children to play on or around the stored machine.

Support the frame on stands and blocks to provide a secure base.



ASSEMBLY INSTRUCTIONS

1. All assembly is done with the auger fully lowered.
2. Remove the standard wheel brackets from the front of the hopper and replace with hydraulic wheel brackets (#1 & #2). These brackets are left and right. One side of the wheel bracket is 1/4" wider than the other edge. The wide edge on both brackets must be turned to the outside of the hopper. Use the same hardware from the standard brackets to mount the hydraulic brackets.
3. Connect the inside ports on the two hydraulic motors using the 54" (10") or 60" (13") hydraulic hose (#26).
4. Attach the 84" hydraulic hoses to the outside ports on the two hydraulic motors. The other end of these hoses connects to the two top ports on the valve assembly. Bolt on the clamp for the valve assembly after assembling hoses.
5. Fit one hose clamp between the hydraulic motors and the valve assembly. A second hose clamp bolts between the safety decals on the upper part of the tube. The decals should still be readable with the clamp in place.
6. The long hoses connect the valve to the tractor.
7. The mover is activated by moving the lever on the valve assembly in either direction (left or right).

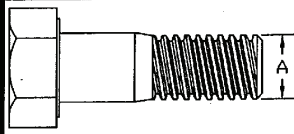
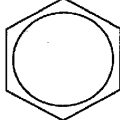

ALERT: The hopper may move quite quickly with some tractors. Be sure everyone is clear of the area when using the mover.

MAINTENANCE

Bolt Torque						
						
Bolt Diameter	SAE2		SAE5		SAE8	
"A"	N.m	lb-ft	N.m	lb-ft	N.m	lb-ft
1/4"	8	6	12	9	17	12
5/16"	13	10	25	19	36	27
3/8"	27	20	45	33	63	45
7/16"	41	30	72	53	100	75
1/2"	61	45	110	80	155	115
9/16"	95	70	155	115	220	165
5/8"	128	95	215	160	305	220
3/4"	225	165	390	290	540	400
7/8"	230	170	570	420	880	650
1"	345	225	850	630	1320	970

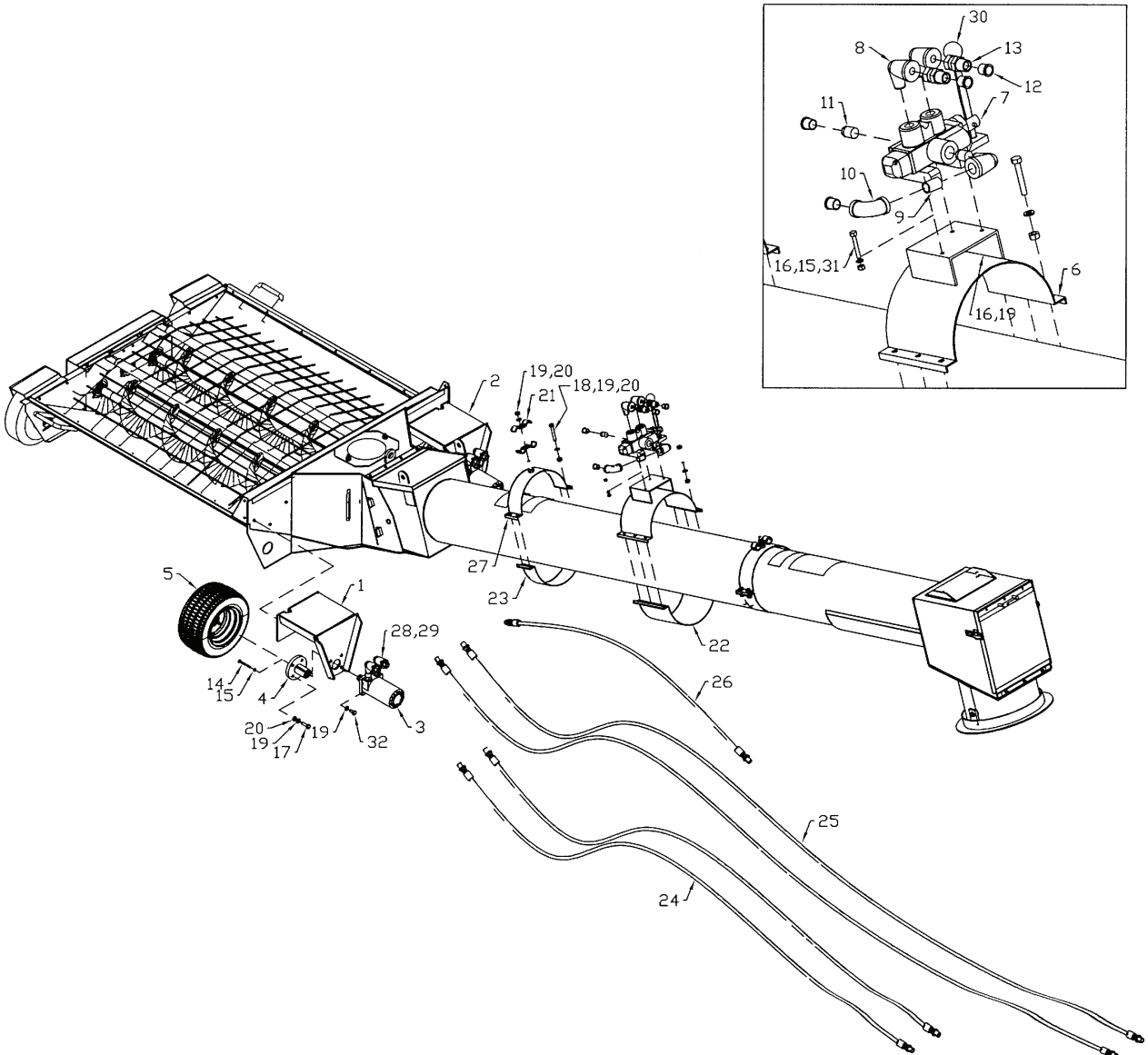

MA-22

WHEN ORDERING PARTS

Always give your dealer the Model, Color and Serial Number of your machine to assist him in ordering and obtaining the correct parts. Use the exploded view and tabular listing of the area of interest to exactly identify the required part.

POWER MOVER

Item #	Part #	Description
1	902569	Wheel Bracket Weldment - L
2	903125	Wheel Bracket Weldment - R
3	905159	Hydraulic Motor 101-1064-009
4	903127	Wheel Hub Weldment
5	960842	4-Bolt Wheel w/ Tire 13 x 5 (4 Ply)
6	902203	Valve Mount Clamp (10")
	902204	Valve Mount Clamp (13")
7	908995	Hydraulic Valve
8	964738	1/2" x 90° Street Elbow (br)
9	967487	1/2" x 2" Nipple
10	964739	1/2" x 90° Elbow
11	967158	3/4" To 1/2" Reducer Bushing
12	81913	Pipe Plug 1/2" NPT
13	966307	Adaptor 1/2 MNPT x 1/2 FNPT - .0520R
14	81532	1/4" x 2 1/4" Hex Bolt (pl)
15	81545	1/4" Lock Washer (pl)
16	81530	1/4" x 1 3/4" Hex Bolt (pl)
17	86171	3/8" x 1 1/4" Hex Bolt (pl)
18	811795	3/8" x 2" Hex Bolt (pl)
19	81593	3/8" Lock Washer (pl)
20	81592	3/8" Hex Nut (pl)
21	964638	Hose Clamp
22	902198	Clamp 3-Bolt (10")
	902200	Clamp 3-Bolt (13")
23	902205	Clamp 2-Bolt (10")
	902207	Clamp 2-Bolt (13")
24	811484	Hydraulic Hose 1/2" x 84"
25	967462	Hydraulic Hose 1/2" x 144" (10")
	967478	Hydraulic Hose 1/2" x 168" (13")
26	29176	Hydraulic Hose 1/2" x 54" (10")
	906087	Hydraulic Hose 1/2" x 60" (13")
27	902206	Hose Holder Clamp Weld't (10")
	902208	Hose Holder Clamp Weld't (13")
28	812829	Elbow 90 3/4 MJIC x 3/4 SWFJIC
29	886897	Adaptor 7/8" MORB x 3/4" MJIC
30	909824	Handle For Valve 908995
31	81544	1/4" Hex Nut (pl)
32	84072	3/8" x 3/4" Hex Bolt (pl)

#	PART #	DESCRIPTION	QTY
1	29176	Hydraulic Hose 1/2" x 54" Lg (10" Backsaver)	1
	906087	Hydraulic Hose 1/2" x 60" Lg (13" Backsaver)	1
2	811484	Hydraulic Hose 1/2" x 84" Lg	2
3	967462	Hydraulic Hose 1/2" x 144" Lg (10" Backsaver)	2
	967478	Hydraulic Hose 1/2" x 168" Lg (13" Backsaver)	2

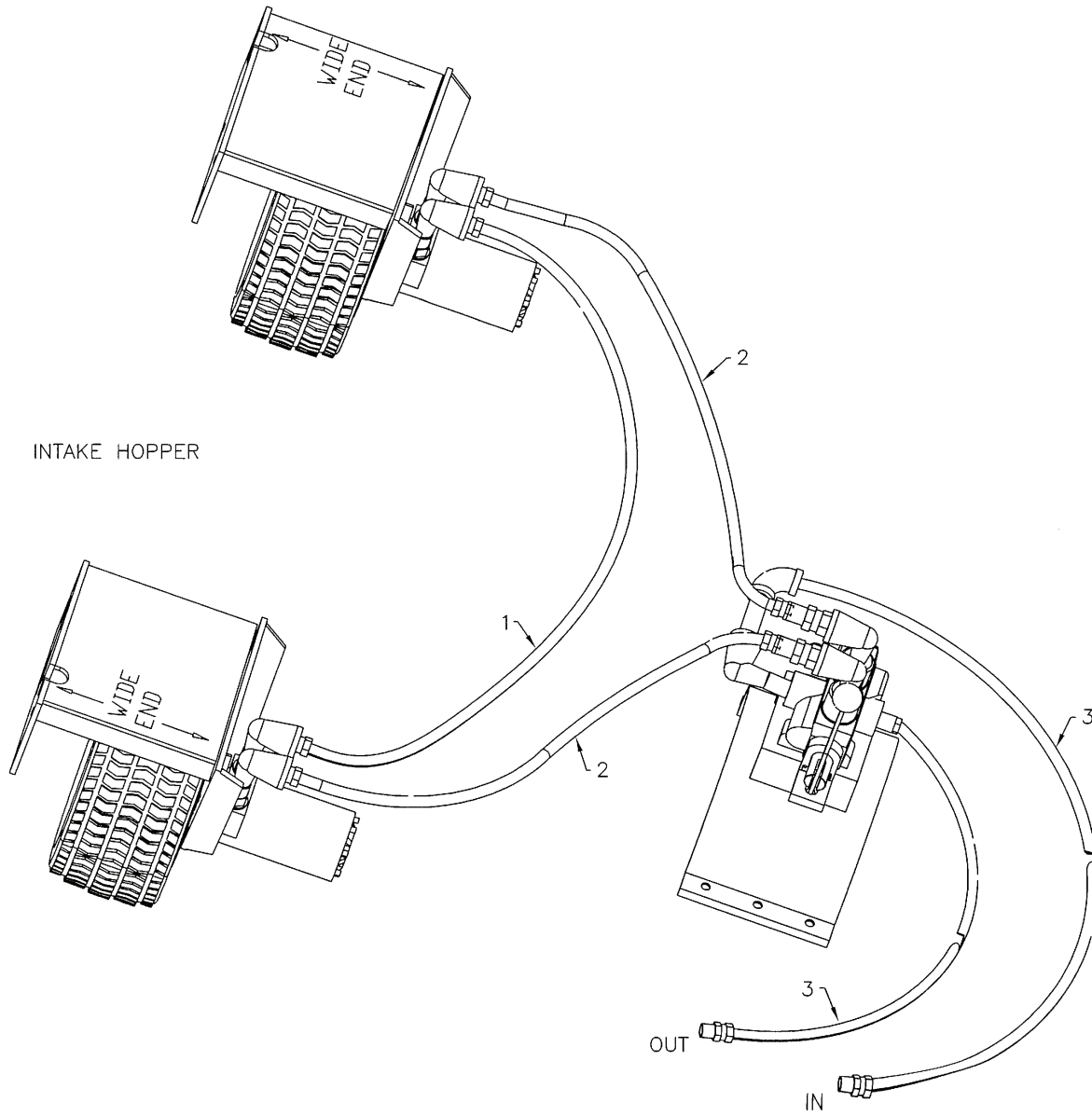

MA-23

DIVISION LOCATIONS

Farm King Division
301 Mountain Street S.
Morden, MB R6M 1X7
Ph.: (204) 822-4467
Fax: (204) 822-6348

Allied/Inland Division
1260 Clarence Avenue
Winnipeg, MB R3T 1T2
Ph.: (204) 284-6100
Fax: (204) 477-2325

B.I.I. Division
1330 43rd Street N.W.
Fargo, ND 58102
Ph: (701) 282-7014
Fax: (701) 282-5865

U.S. WAREHOUSES

AR, West Memphis
(870) 732-3132

GA, Stone Mountain
(770) 908-9439

ID, Meridian
(208) 887-6006

IN, Clarksville
(812) 284-3376

KS, Wichita
(316) 265-9577

MN, Lakeville
(952) 469-5267

MT, Billings
(406) 248-7771

ND, Bismarck
(701) 223-1886

ND, Fargo
(701) 282-7003

NE, Blair
(402) 426-8211

OH, Youngstown
(330) 793-0862

OR, Beaverton
(503) 641-1865

SD, Huron
(605) 352-8616

TX, Houston
(713) 928-2632

UT, Salt Lake City
(801) 972-4321

WI, Portage
(608) 742-1370

CANADIAN WAREHOUSES

B.C., Abbotsford
(604) 864-2665

AB, Edmonton
(780) 962-6991

SK, Regina
(306) 781-2300

ON, Woodstock
(519) 539-0435

QC, Dorion
(450) 455-4840

OFFSHORE WAREHOUSES

Burando Hill
Katanning
W. Australia
011-618-98-214422

Chihuahua, Mexico
011-52-158-90306

John Kerr Equipment Ltd.
Wilcoxholm Farm
Linlithgow, W. Lothian
Scotland
011-441-506-842280

Skovde, Sweden
011-46-500-452651

Naestved, Denmark
011-45-557-29511

bühler

Buhler Manufacturing

**301 Mountain Street S.
Morden MB.
R6M 1X7
Ph.: (204) 822-4467
Fax: (204) 822-6348
www.buhler.com**